

The logo for Gill, featuring a large, bold, white 'G' followed by a lowercase 'i' with a circular dot above it, and two vertical bars of equal height to the right, all in white on a black background.

Gill

Stealth Racer_w017

Instruction Manual

**This watch comes with a 2 year warranty.
For warranty issues please contact your nearest stockist.
Proof of purchase required.**

1.0 Introduction

Thank you for purchasing the Stealth Racer Watch. This watch features real time, dual time, race countdown timer, stopwatch and compass modes in addition to many other functions.

Your watch will be supplied in Power Down Mode in order to preserve battery life. To exit, press and hold any button for 5 seconds.

Please follow these guidelines in order to maximise the lifetime of the Stealth Timer Watch:

- Avoid exposing the watch to extreme conditions over extended periods
- Avoid rough use or sudden impacts
- To ensure water-resistant integrity, we recommend the use of a certified watch repairer when opening the watch case
- Clean with a soft cloth when needed
- Power down your watch and store in a dry place when not in use for extended periods

2.0 Buttons Operation Summary

Mode Button [M]

- Press to scroll through Function Modes
- In any Function Mode: Press to return to Function Mode Menu.
- In any setting display: Press to exit and return to previous level.

ST./ STP Button [S/S]

- In Clock Mode: Press to toggle Home & Dual Time.
- In Regatta Mode: Press to start/stop countdown timer.
- In Chronograph Mode: Press to start/stop timers.

OK/LK Button [O/L]

- Function Modes: Press to enter individual Functions.
- Settings Mode: Press to select option from menu.
- In Regatta Mode: Press to toggle lock/unlock.
- In Chronograph Mode: Press to recall previous lap time.

Lap/Reset [L/S]

- In Clock Mode: Press and hold for 5 seconds to enter Power Save Mode.

- In Regatta Mode & Chronograph Mode: Press and hold for 2 seconds to reset when stopped.

Light [L]

- In any mode/display, press to turn ON the EL backlight for about 3 seconds.

Note: The button operations are summarised as above, for detailed operating instructions, please continue reading.

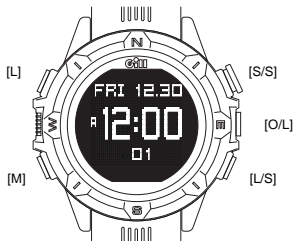

3.0 Major Function Modes

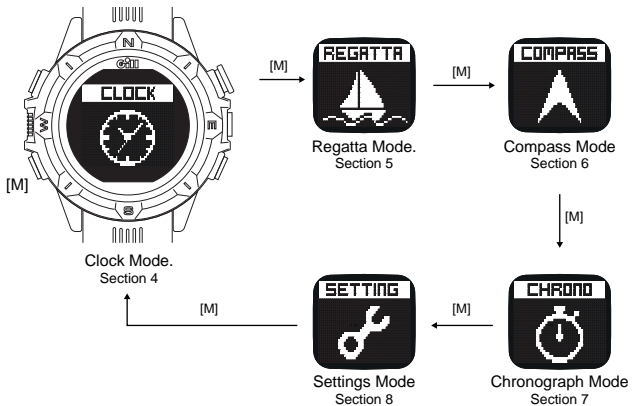

4.0 Clock Mode

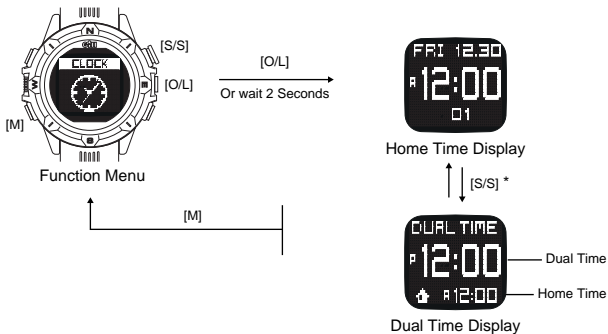

* ST.STP Button [S/S]

- Press to toggle Home & Dual Time Display for 5 seconds.
- Press and hold for 2 seconds changed display will be kept.

5.0 Regatta Mode

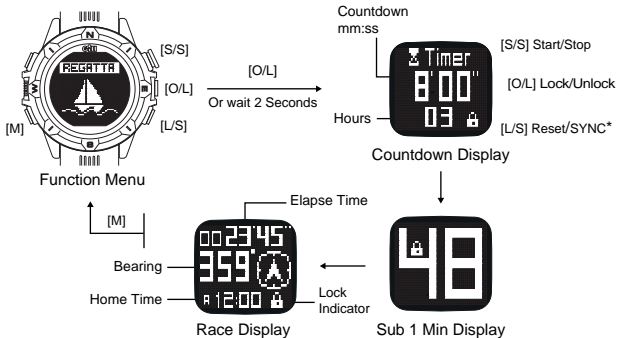

* Lap/Reset Button [L/S]

- When timer is stopped press and hold for 2 seconds to reset.
- SYNC, when the Countdown Timer is running, press the [L/S] button to round off the counting time

Auto Lock Function:

- In Regatta Mode the keys can be set to Auto Lock preventing accidental operation - this can be set ON/OFF in Settings Mode.

6.0 Compass Mode

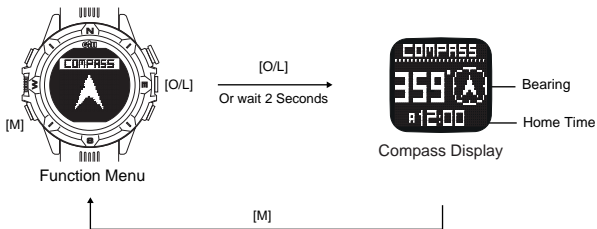

7.0 Chronograph Mode

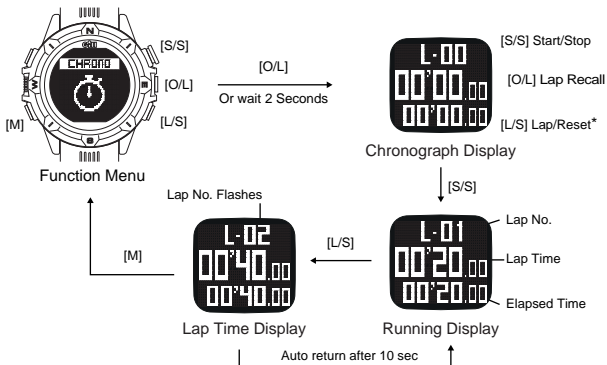

* Lap/Reset Button [L/S]

- When timer is running press to set lap time.
- When timer is stopped press and hold for 2 seconds to reset.

7.0 Chronograph Mode _ cont.

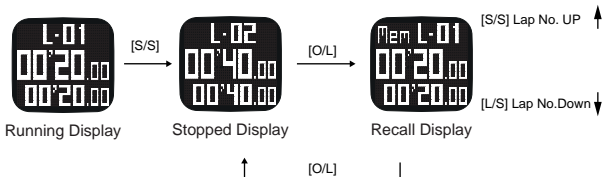

Addition display information:

Minute Second 1/100 S

00'00.00

Less than 1 Hour

Hour Minute Second

01:00.00

Over 1 Hour

Maximum Time: 23H 59M 59S

Maximum Lap Count: 99

8.0 Settings Mode

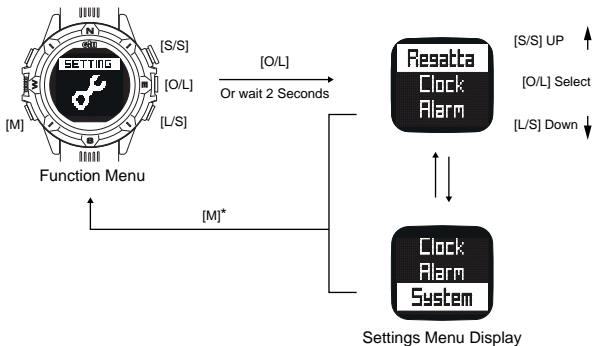

* Mode Button [M]

- In any setting display: Press to exit and return to previous level.

8.1 Regatta Settings _ SYNC



Synchronisation Function

- If the timer is in "SYNC Down" status, the timer will round down to the next full minute.
- If the timer is in "SYNC Round" status, the timer will round down or up to the closest minute.

8.1.1 Regatta Settings _ Timer

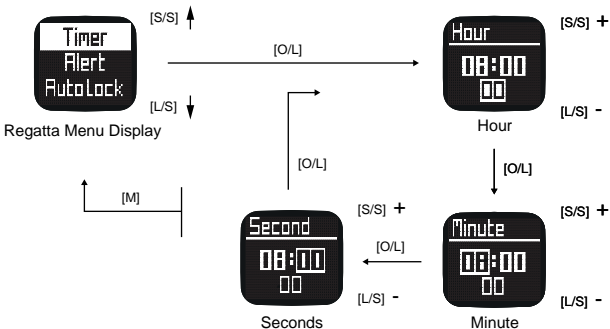

8.1.2 Regatta Settings _ Alert

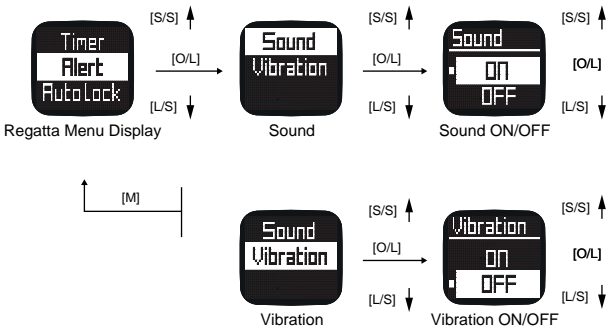

Countdown Alert:

- The Countdown Alert can be set to Sound, Vibrate or a combination of Both.

- Once set the Alert will activate as follows:

Alert once per minute for the last 10 minutes, once per 10 seconds for the final minute and once per second for the last 5 seconds. 3 times for 30 seconds when countdown is finished.

8.1.3 Regatta Settings _ Auto Lock

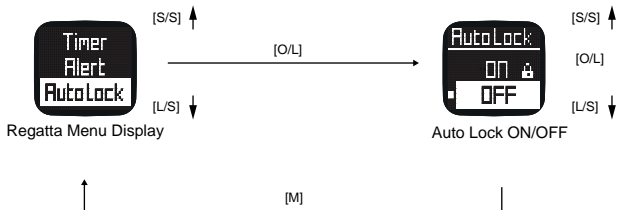

8.2 Clock Settings _ Time

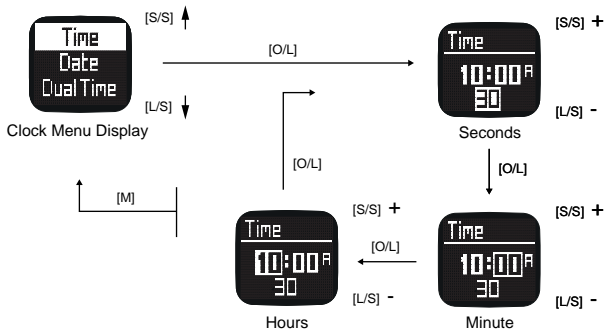

8.2.1 Clock Settings _ Date

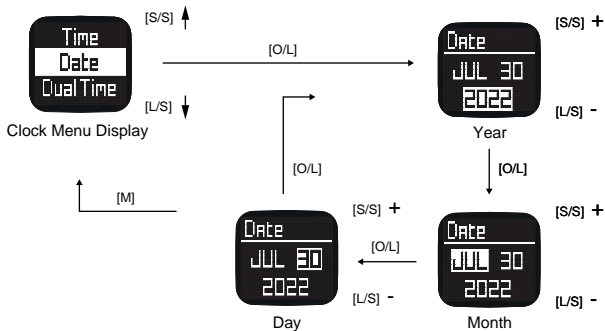

8.2.2 Clock Settings _ Dual Time

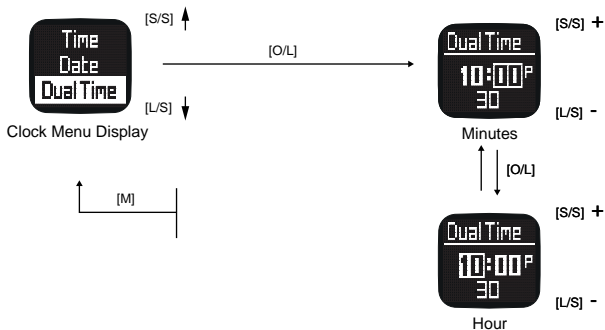

8.2.3 Clock Settings _ Format

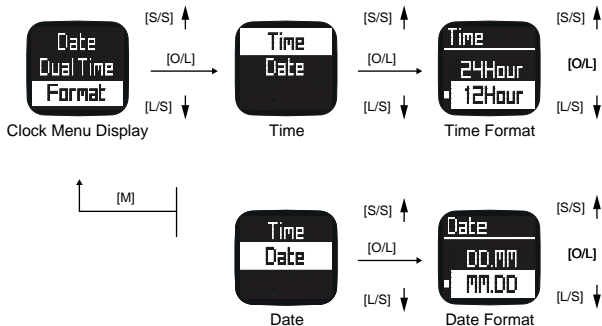

8.3 Alarm Settings

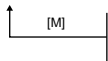

8.4 System Settings _ Keytone



8.4.1 System Settings _ Contrast



8.4.2 System Settings _ Compass

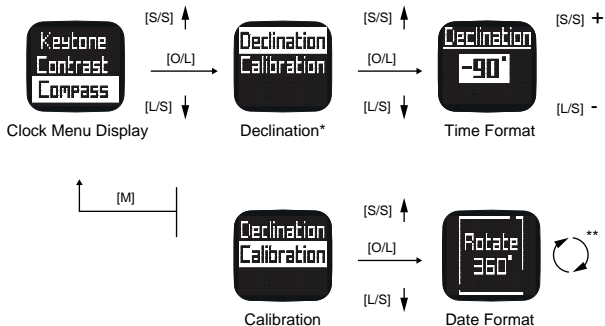

*Declination:

Declination accounts for the difference between True North and Magnetic North and should be set according to your current location

** To Calibrate Compass rotate watch through 360 degrees until boarder is complete.

8.4.3 System Settings _ Standby Mode



9.0 Power Modes.

This watch includes three power saving Functions designed to help the battery last longer:

Standby Mode.

- When no key is pressed for 1 hour, the watch will enter Standby Mode.
- When in Standby Mode only the current time will be shown
- To exit Standby Mode: press any key
- Standby Mode can be set On/Off in System Settings



Standby Mode
12 Hour Display



Standby Mode
24 Hour Display

Power Save Mode.

- Power Save Mode can only be entered when in Clock Mode
- To enter Power Save Mode: press and hold Lap/Reset [L/S] for 5 seconds
- To exit Power Save Mode: press any key

9.0 Power Modes _ Cont.

Power Down Mode.

- Power Down Mode can be only entered while in Clock Mode
- To enter Power Down Mode: press and hold ST./STP [S/S] & Mode Button [M] for 5 seconds
- To exit Power Save Mode: press any key press and hold 5 seconds

When in Power Saving Mode or Power Down Mode the display will be off but all timers will continue running.

Battery Low Indication.

- The low battery indicator appears on the display when battery capacity is low, it is recommended to replace the battery at this time.



10.0 Specifications

Clock Mode:

- Hour, minute, second, am, pm, month, day, and day of week
- Dual Time mode
- 12-hour or 24-hour format
- Auto-Calendar pre-programmed from the year 2000 to 2099
- Day/Month or Month/Day format

Regatta Mode:

- User defined Countdown Timer
- Time Synchronisation
- Key lock function
- Count-up range: 23H 59M 59S

Compass Mode:

- Bearing
- Current time

Chronograph Mode:

- Resolution 1/100 second
- Recall lap time
- Count-up range: 23 Hours 59 Minutes 59 Seconds
- Max. Lap Count: 99 Laps

Daily Alarm

- 1 Daily Alarm
- Sounds for 30 seconds at alarm time

Others

- Electro-Luminescent (EL) backlight
- Battery: Single 3V lithium battery (CR2032)